



VACOLUX[®]
LIGHTING

LED STRIP LIGHT

SNI

ETCS - 01

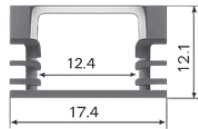
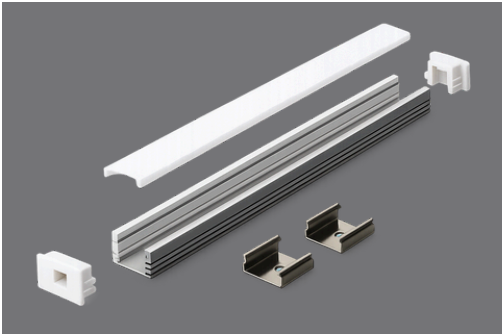

Include: 1M Aluminium Profile
1M Cover
Two End Cap
Two Clips

Suitable For: 2835 120led/M 8MM PCB
2835 240led/M 10MM PCB

ETCS - 02

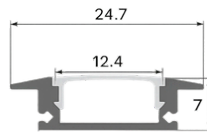

Include: 1M Aluminium Profile
1M Cover
Two End Cap
Two Clips

Suitable For: 5054 120led/M 12MM PCB
2835 240led/M 10MM PCB

ETCS - 03

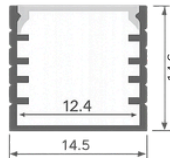
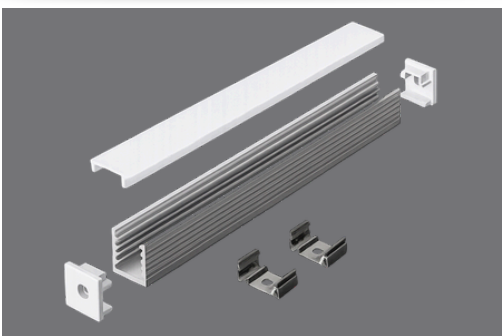

Include: 1M Aluminium Profile
1M Cover
Two End Cap
Two Clips

Suitable For: 2835 240led/M 8MM PCB

ETCS - 01

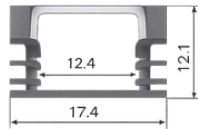
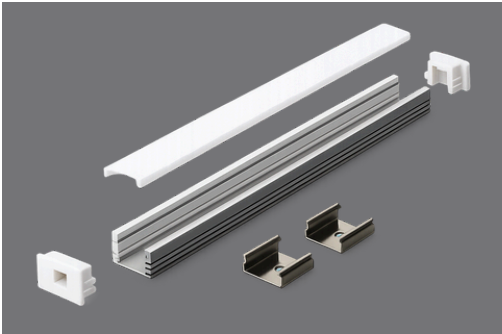

Include: 1M Aluminium Profile
1M Cover
Two End Cap
Two Clips

Suitable For: 2835 120led/M 8MM PCB
2835 240led/M 10MM PCB

ETCS - 02

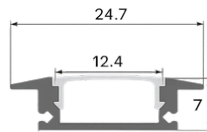

Include: 1M Aluminium Profile
1M Cover
Two End Cap
Two Clips

Suitable For: 5054 120led/M 12MM PCB
2835 240led/M 10MM PCB

ETCS - 03

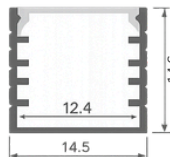
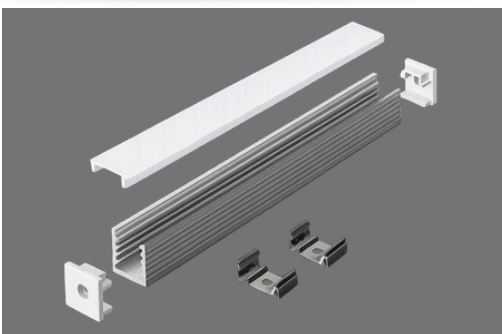

Include: 1M Aluminium Profile
1M Cover
Two End Cap
Two Clips

Suitable For: 2835 240led/M 8MM PCB

ETCS - 04

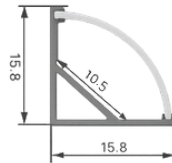

Include: 1M Aluminium Profile
1M Cover
Two End Cap
Two Clips

Suitable For: 2835 120led/M 8MM PCB
2835 240led/M 10MM PCB

ETCS - 05

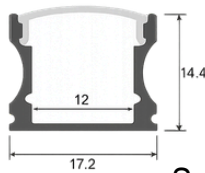

Include: 1M Aluminium Profile
1M Cover
Two End Cap
Two Clips

Suitable For: 5054 120led/M 12MM PCB
2835 240led/M 10MM PCB

ETCS - 06

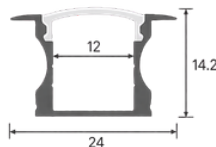

Include: 1M Aluminium Profile
1M Cover
Two End Cap
Two Clips

Suitable For: 5054 120led/M 12MM PCB
2835 240led/M 10MM PCB

ETCS - 07

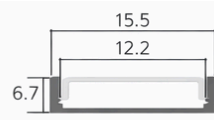
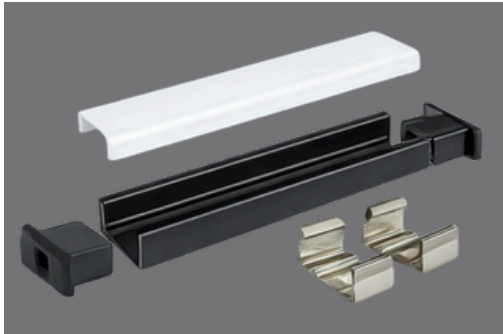

Include: 2M Aluminium Profile
2M Cover
Two End Cap
Four Clips

Suitable For: 2835 120led/M 8MM PCB
2835 240led/M 10MM PCB

ETCS - 08

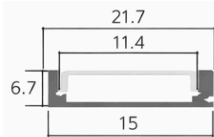
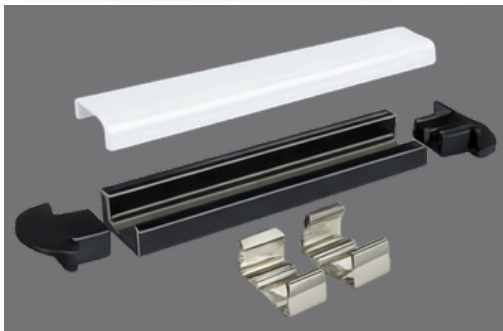

Include: 2M Aluminium Profile
2M Cover
Two End Cap
Four Clips

Suitable For: 2835 120led/M 8MM PCB
2835 240led/M 10MM PCB

ETCS - 09

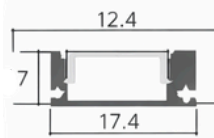
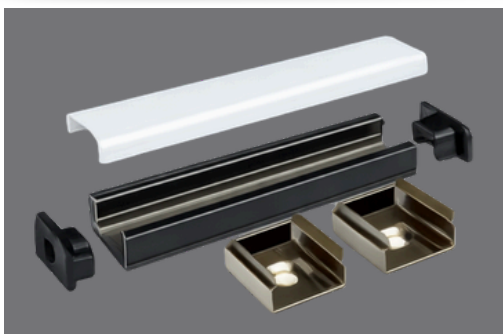

Include: 2M Aluminium Profile
2M Cover
Two End Cap
Four Clips

Suitable For: 5054 120led/M 12MM PCB
2835 240led/M 10MM PCB

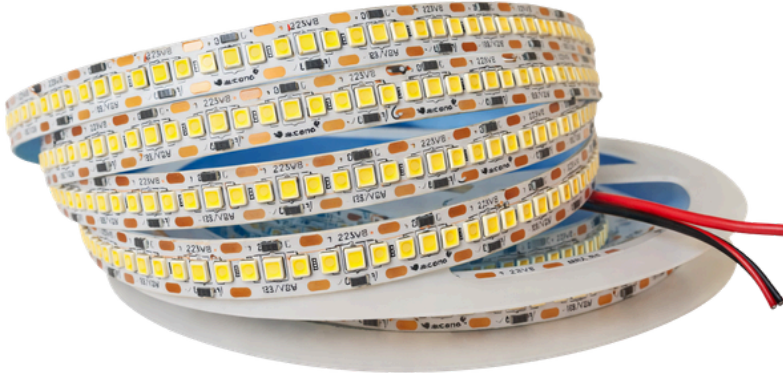

Color :

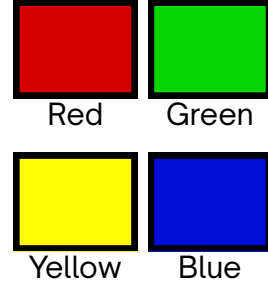

Red

Green

Yellow

Blue

SMD2835

No Flicker

High Color Rendering Index

Anti-Glare

LED Type	Power	Brightness	CRI	Voltage	SIZE	CCT
SMD2835 60pcs/M	4.8 W/m	24-26 lm/LED	90	12V/24V	PCB W : 8mm L : 5m/reel	CW 10000K-11000K
SMD2835 120pcs/M	9.6 W/m	24-26 lm/LED	90	12V/24V	PCB W : 8mm L : 5m/reel	NW 4000K-4500K
SMD2835 240pcs/M	19.2 W/m	24-26 lm/LED	90	12V/24V	PCB W : 10mm L : 5m/reel	WW 2700K-3000K

Material

Monocrystalline Silicon



Product Dimension

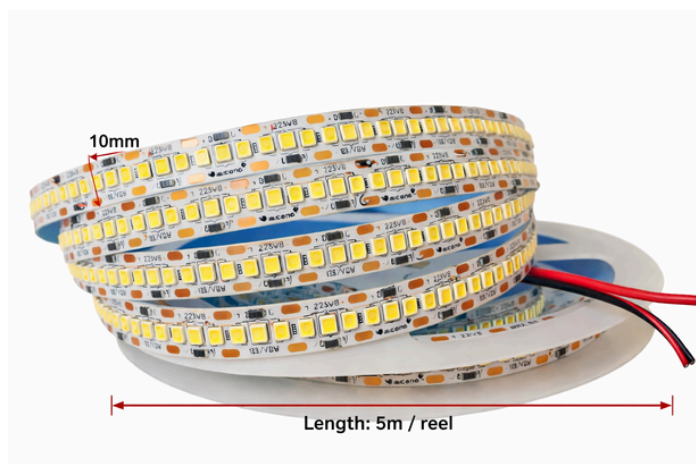

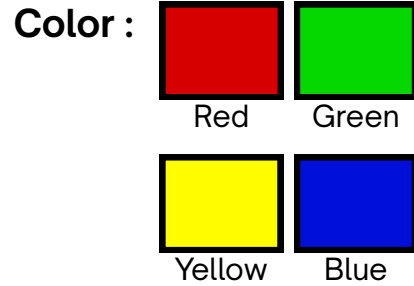
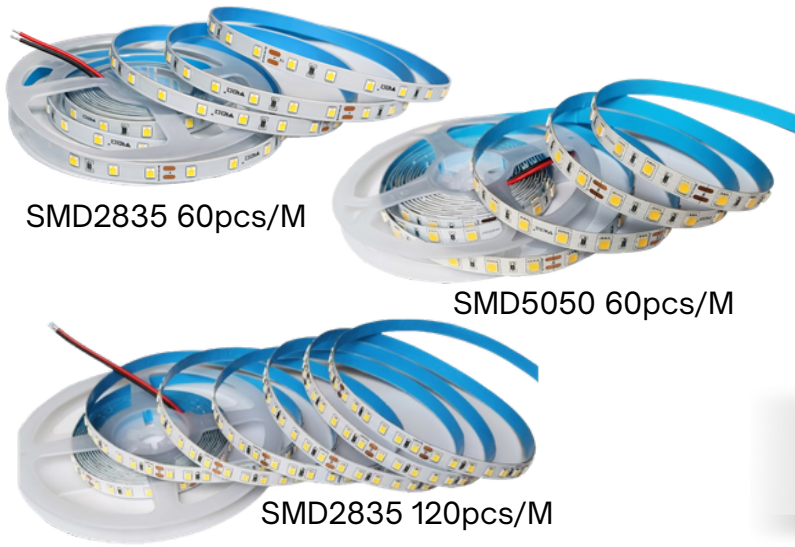

SMD2835 & SMD5050

No Flicker

High Color Rendering Index

Anti-Glare

LED Type	Power	Brightness	CRI	Voltage	SIZE	CCT
SMD2835 60pcs/M	5.5 W/m	24-26 lm/LED	90	24V	PCB W : 8mm L : 5m/reel	CW 10000K-11000K
SMD2835 120pcs/M	11 W/m	24-26 lm/LED	90	24V	PCB W : 8mm L : 5m/reel	NW 4000K-4500K
SMD5050 60pcs/M	14.4 W/m	24-26 lm/LED	90	24V	PCB W : 10mm L : 5m/reel	WW 2700K-3000K

Material

Monocrystalline Silicon



Product Detail

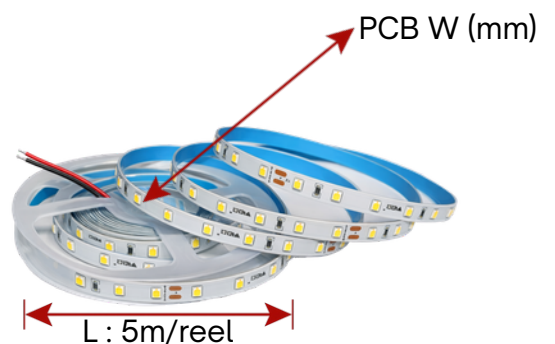
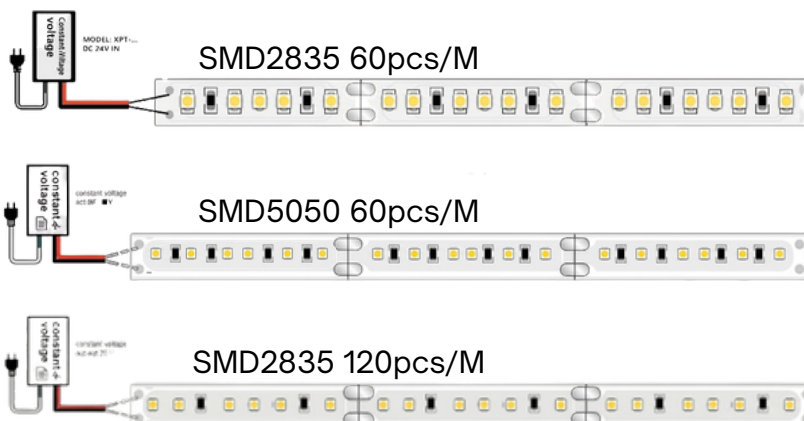



SMD5050

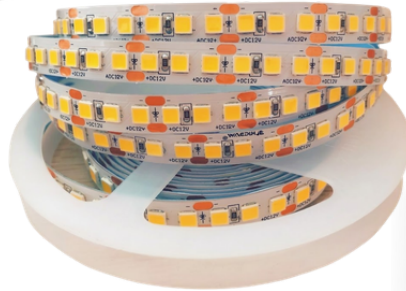

SMD5054

Color :

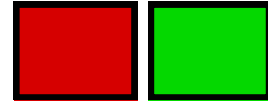

Red

Green

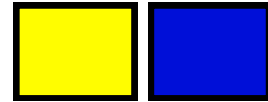

Yellow

Blue

SMD5050 & SMD5054

No Flicker

High Color Rendering Index

Anti-Glare

LED Type	Power	Brightness	CRI	Voltage	SIZE	CCT
SMD5050 60pcs/M	14.4 W/m	21-23 lm/LED	90	12/24V	PCB W : 10mm L : 5m/reel	CW 10000K-11000K NW 4000K-4500K
SMD5054 120pcs/M	11 W/m	21-23 lm/LED	90	12/24V	PCB W : 12mm L : 5m/reel	WW 2700K-3000K

Material

Monocrystalline Silicon



Product Dimension



SMD5050



SMD5054

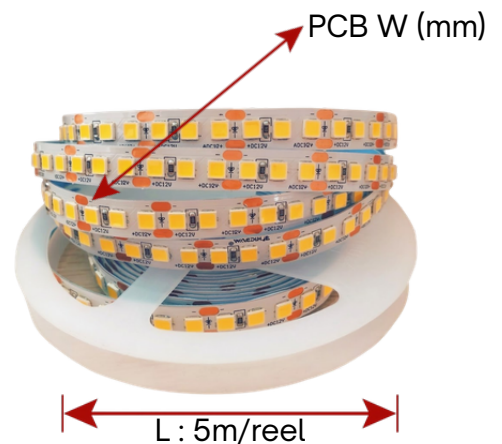

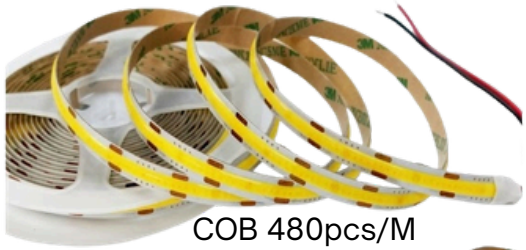

COB 480pcs/M



COB 528pcs/M

Color :

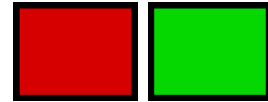

Red

Green

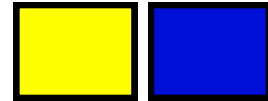

Yellow

Blue

COB

No Flicker

High Color Rendering Index

Anti-Glare

LED Type	Power	Brightness	CRI	Voltage	SIZE	CCT
COB 480pcs/M	10 W/m	100LM/M	>90	12/24V	PCB W : 10mm L : 5m/reel	CW 6000K-6500K NW 4000K-4500K
COB 528pcs/M	14 W/m	100LM/M	>90	12/24V	PCB W : 12mm L : 5m/reel	WW 2700K-3000K

Material

Monocrystalline Silicon



Product Dimension

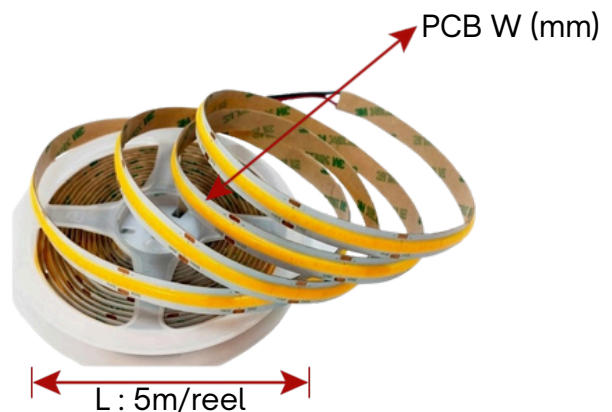
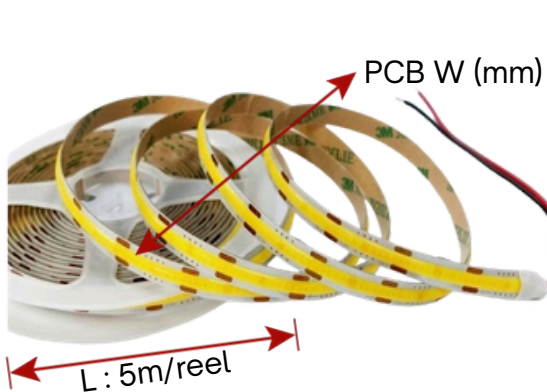



Color :

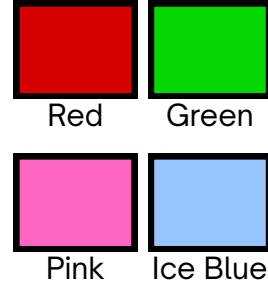

2835

No Flicker

High Color Rendering Index

Anti-Glare

Wireless

LED Type	Power	Brightness	CRI	Voltage	Cut Unit	CCT
2835 120pcs/M	8 W/m	750lm/LED	>90	220V		WH 6000K WW 3000K
2835 120pcs/M	9 W/m	800lm/LED	>90	220V	10cm	NW 4000K

Material

Monocrystalline Silicon



Product Dimension

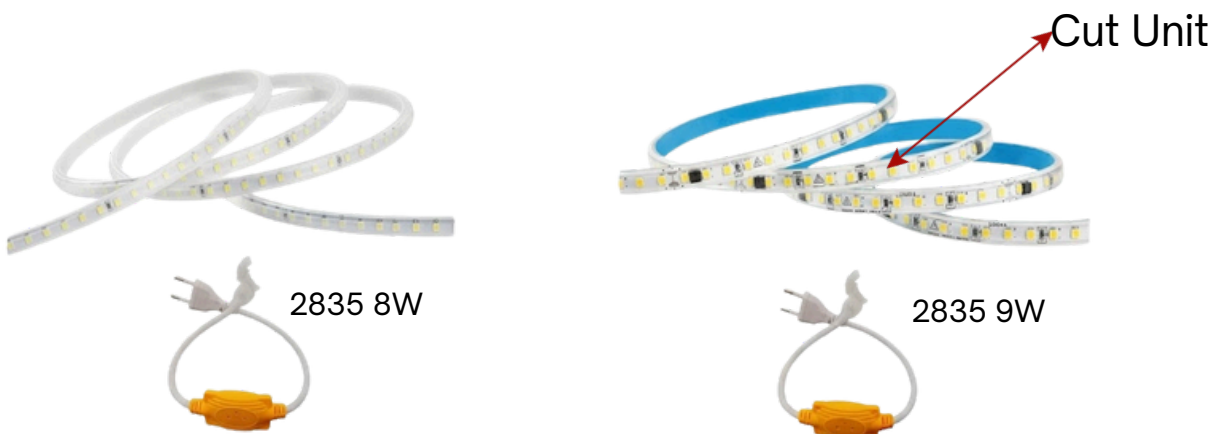



Color :

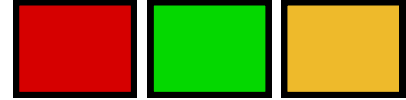

Red

Green

Gold



Pink

Ice Blue

Purple

NEON SERIES

No Flicker

High Color Rendering Index

Anti-Glare

Wireless

LED Type	Power	Brightness	CRI	Voltage	Cut Unit	CCT
NEON 120pcs/M	8 W/m	220lm/LED	>90	220V	8 x 16mm	WH 6000K WW 3000K NW 4000K

Material

Monocrystalline Silicon



Product Dimension

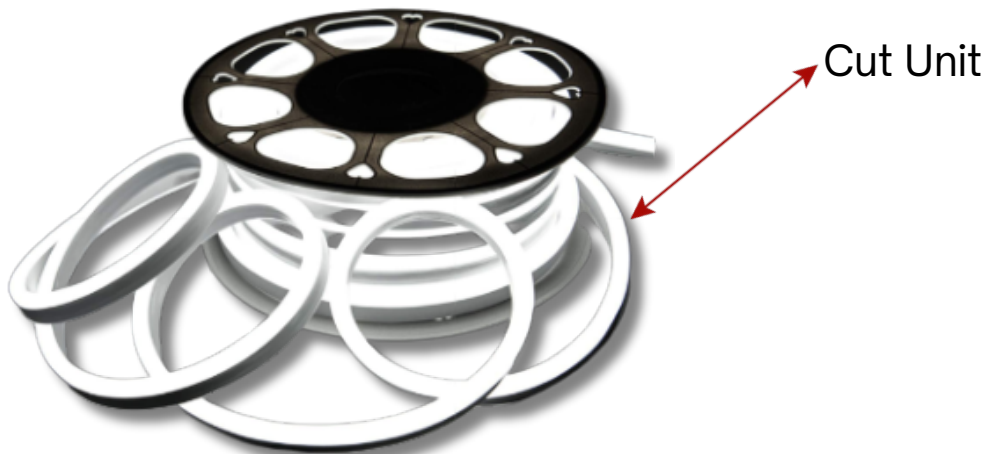



COB 288pcs/M

Color : 
Blue

COB

No Flicker

High Color Rendering Index

Anti-Glare

LED Type	Power	Brightness	CRI	Voltage	SIZE	CCT
COB 288pcs/M	10 W/m	750lm/LED	>90	220V		WH 6000K WW 3000K NW 4000K

Material

Monocrystalline Silicon



Product Dimension

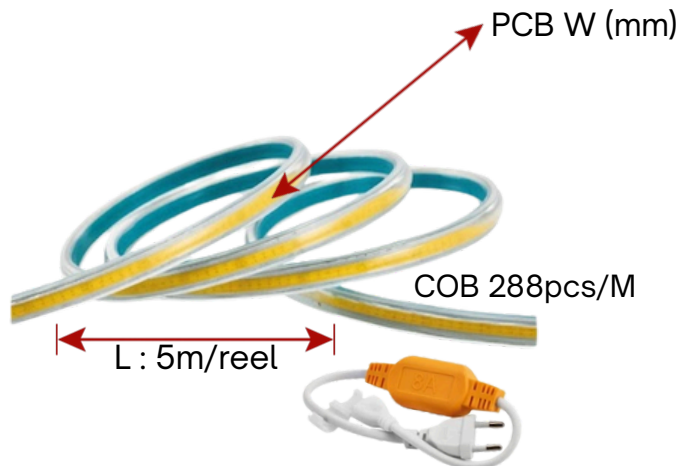

COB - 528P

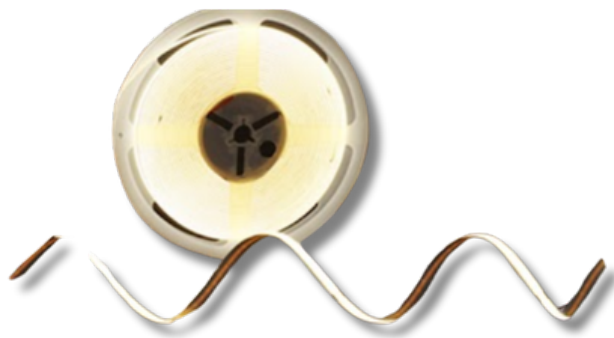

COB - 528P



No Flicker

High Color Rendering Index

Anti-Glare

Item Number	Power	Lumen	Beam Angle	Voltage	Lifetime	CRI	CCT
COB - 528P	14W/M	100LM/W	120°	12V	50,000hrs	RA >90	3000K 4000K 6500K
COB - 480P	10W/M	100LM/W	120°	12V	50,000hrs	RA >95	

Material

Body : PC / ABS



2835 - 132P



2835 - 128P



2835 - 72P - 24V



2835 - 72P - 12V



No Flicker

High Color Rendering Index

Anti-Glare

Item Number	Power	Lumen	Beam Angle	Voltage	Lifetime	CRI	CCT
2835 - 132P	14.6W/M	1500LM/W	120°	12V	50,000hrs	RA >90	3000K
2835 - 128P	16W/M	2200LM/W	120°	24V	50,000hrs	RA >90	4000K
2835 - 72P	11.5W/M	1200LM/W	120°	24V	50,000hrs	RA >90	6500K
2835 - 72P	11W/M	1100LM/W	120°	12V	50,000hrs	RA >90	

Material

Body : PC / ABS



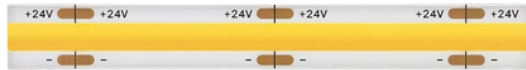

528P

No Flicker

High Color Rendering Index

Anti-Glare

Item Number	Power	Lumen	Voltage	Length	CRI	CCT
COB - 240D	10W/M	650LM/W	AC185-230V	10M/ROLL	RA ≥90	2200K 3000K 4000K 6500K Ice Blue

Material

Body : PC / ABS



Product Detail

